

30.03.06 PROPUESTAS SOLAR
 PFC. PABLO REY MAZÓN. ESCUELA FP.
 CICLOS F. SUPERIOR. DISEÑO
 ILUSTRACIÓN GRABADO

todas las medidas en metros

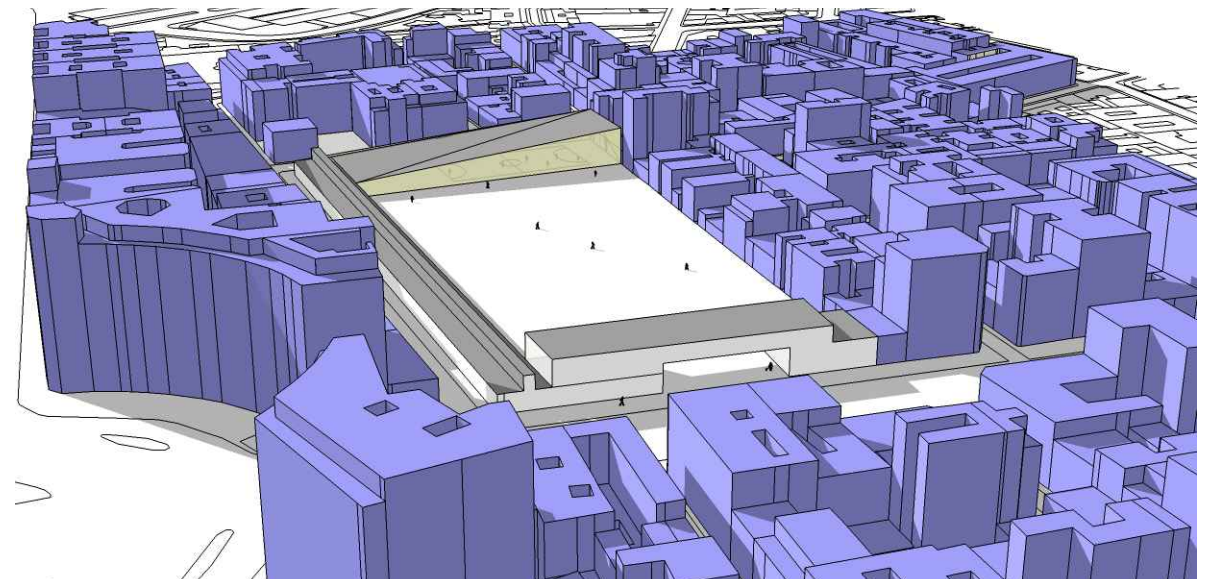

U

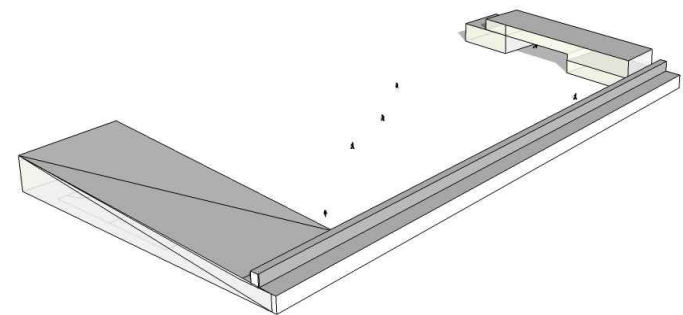

superficie manzana	19256	
m ² construidos pfc:	5500	
m ² ocupados pfc:	4871	25,3%
Superficie libre:	8971	46,5%
Edificios preexistentes:	4233	21,9%
nº de plantas:	1-3	

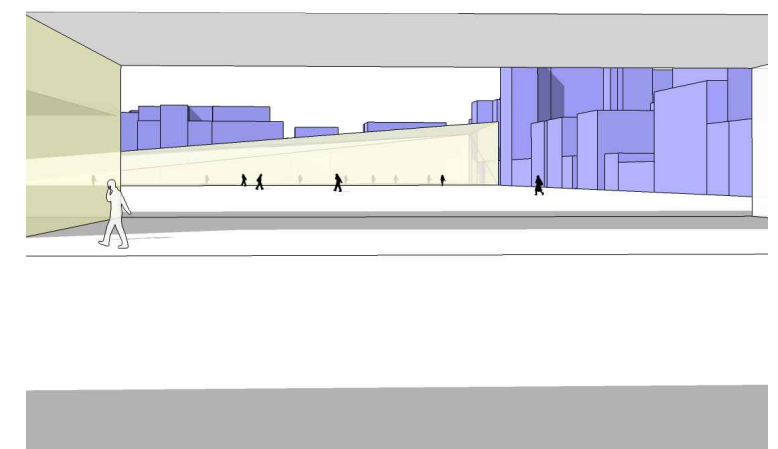
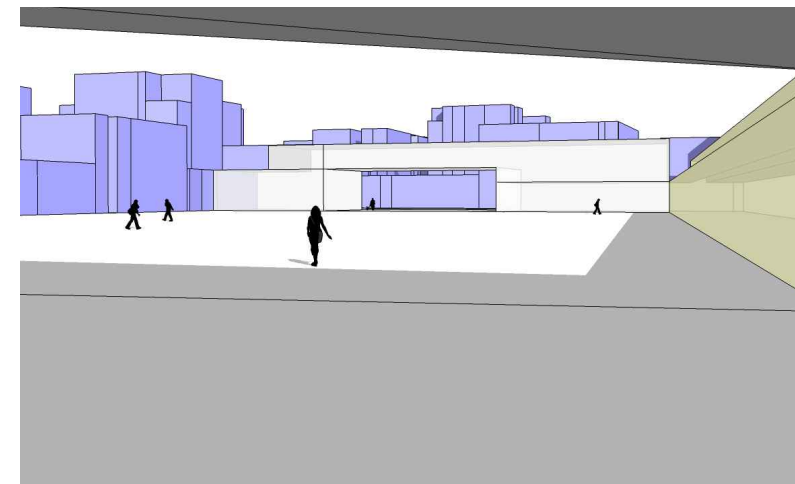
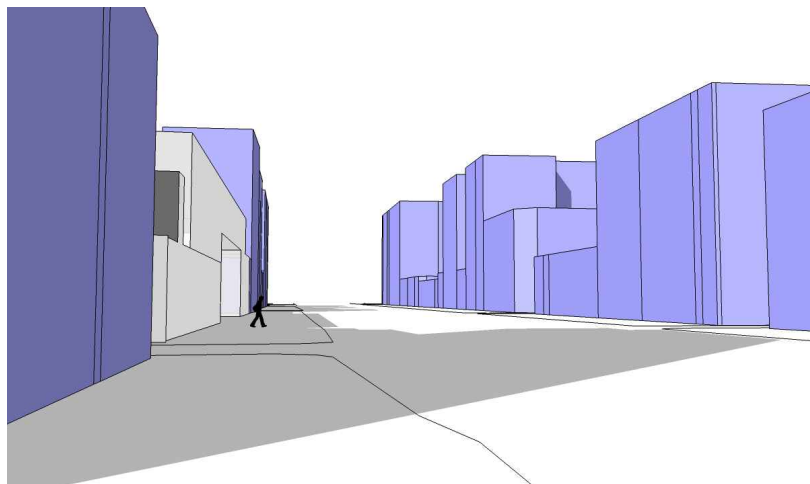
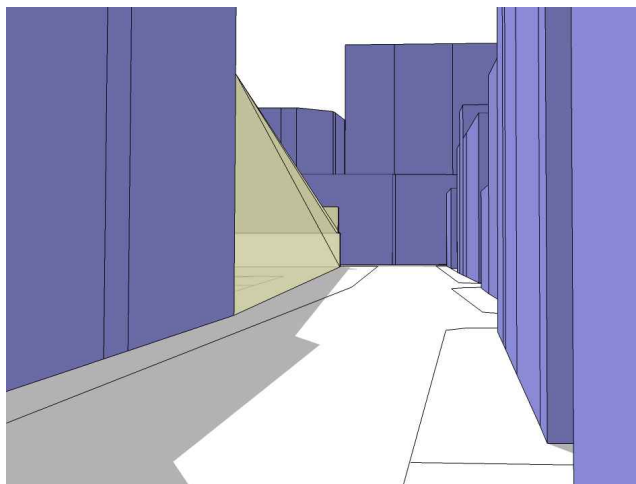
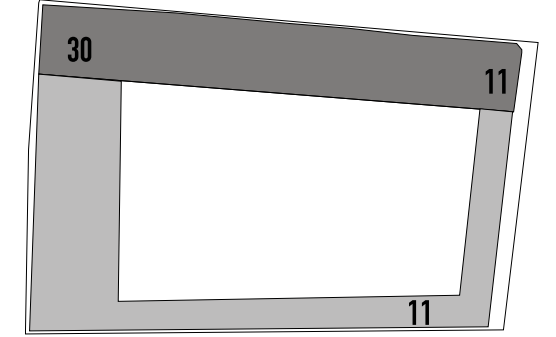



30.03.06 PROPUESTAS SOLAR
 PFC. PABLO REY MAZÓN. ESCUELA FP.
 CICLOS F. SUPERIOR. DISEÑO
 ILUSTRACIÓN GRABADO

todas las medidas en metros

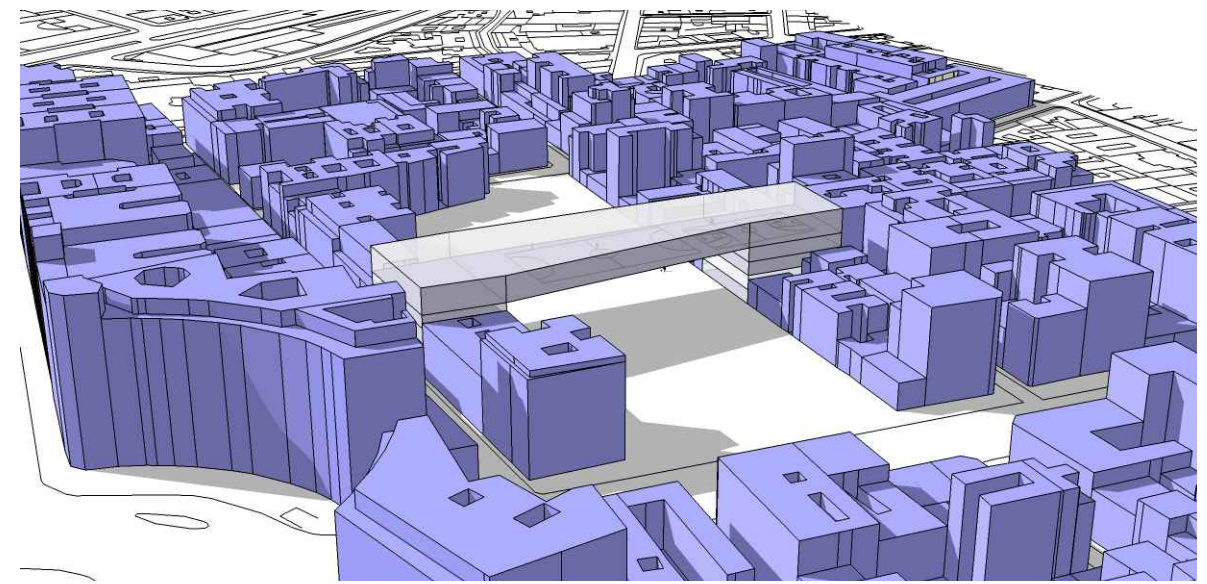

P

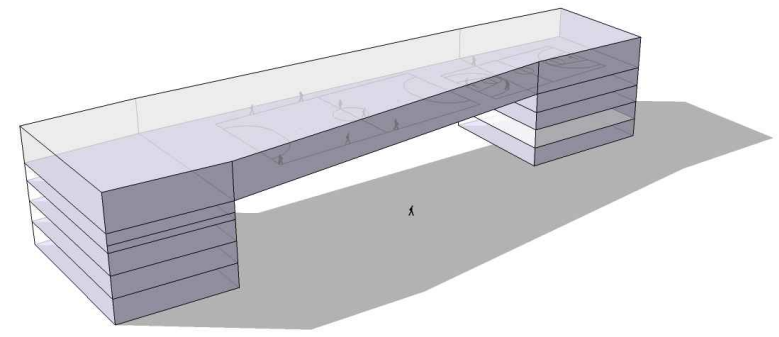

superficie manzana	19256	
m ² construidos pfc:	6100	
m ² ocupados pfc:	1178	6,1%
Superficie libre:	9924	51,5%
Edificios preexistentes:	7017	21,9%
nº de plantas:	5	

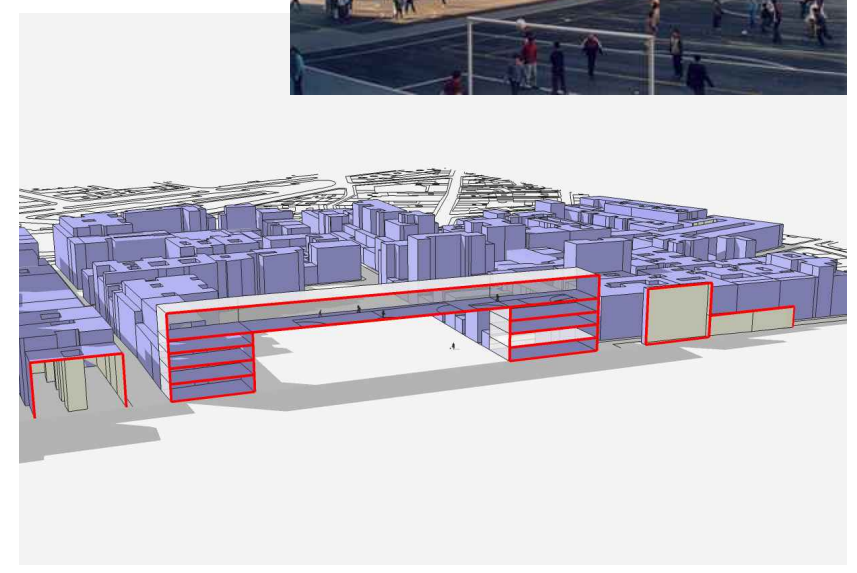
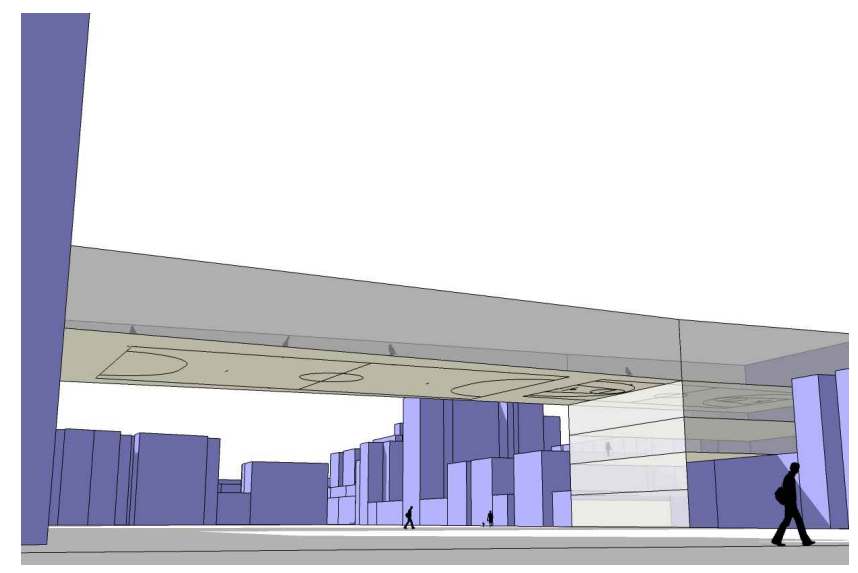
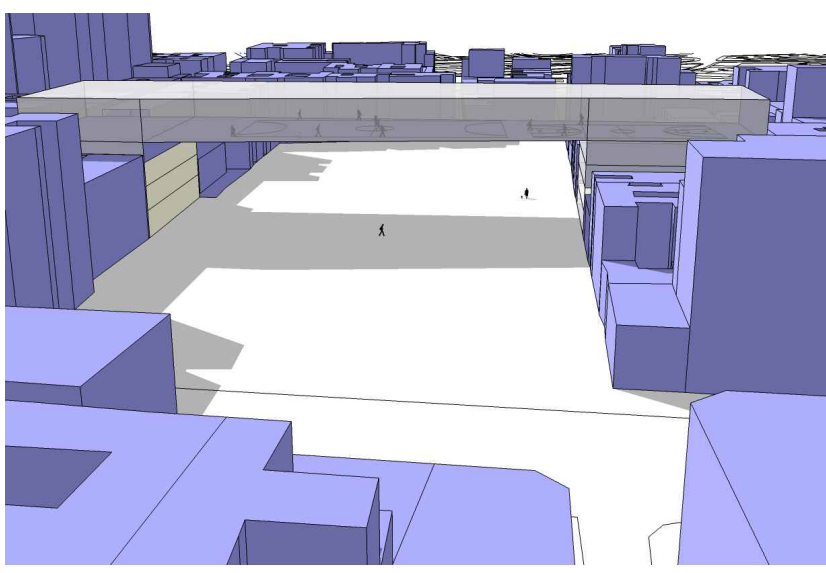
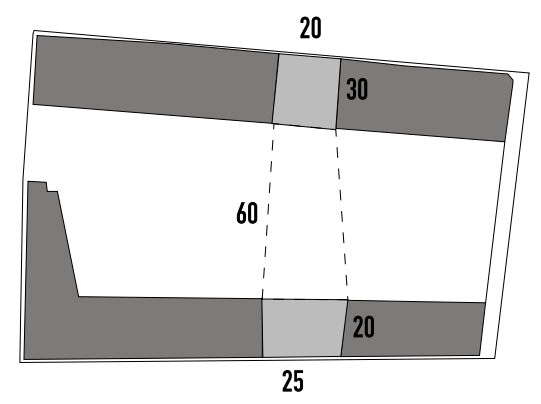



30.03.06 PROPUESTAS SOLAR
 PFC. PABLO REY MAZÓN. ESCUELA FP.
 CICLOS F. SUPERIOR. DISEÑO
 ILUSTRACIÓN GRABADO

todas las medidas en metros

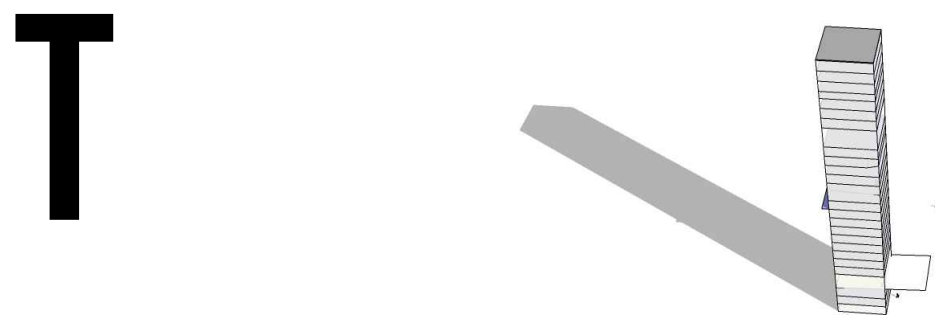
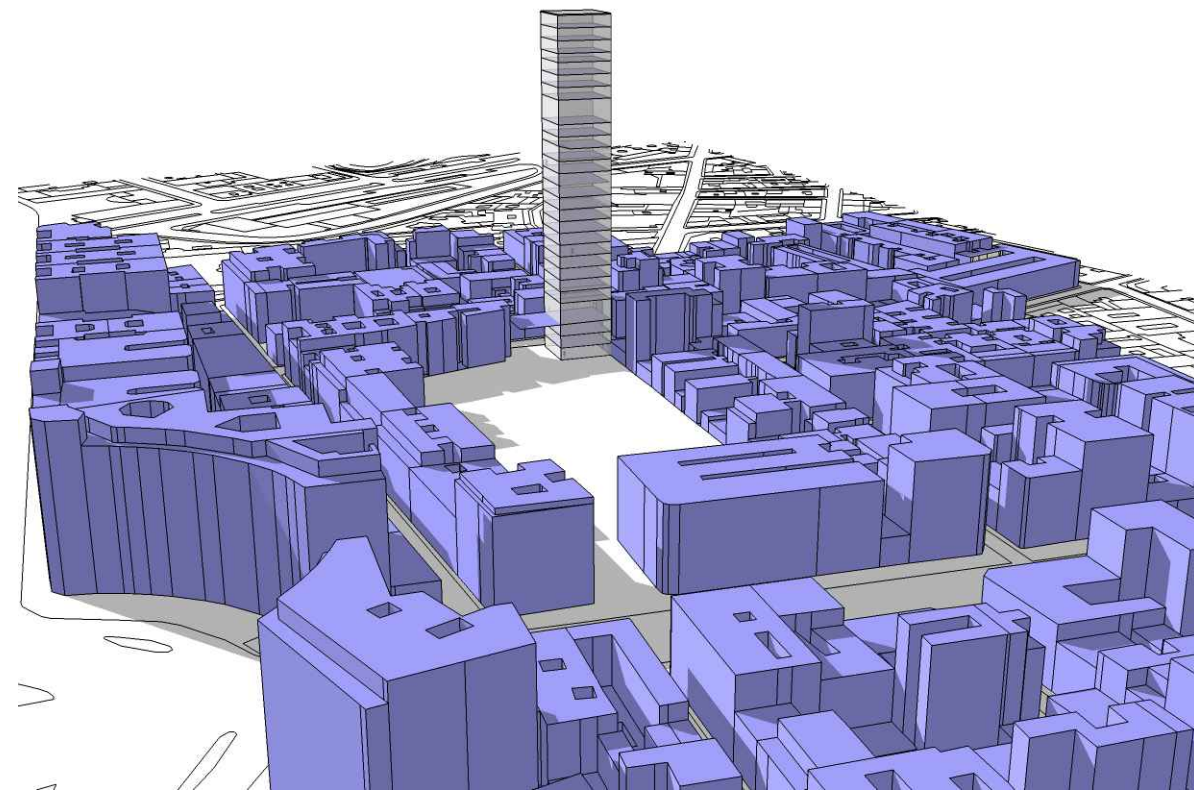

superficie manzana	19256	
m ² construidos pfc:	6075	
m ² ocupados pfc:	225	1,1%
Superficie libre:	9474	46,5%
Edificios preexistentes:	8195	21,9%
nº de plantas:	27	

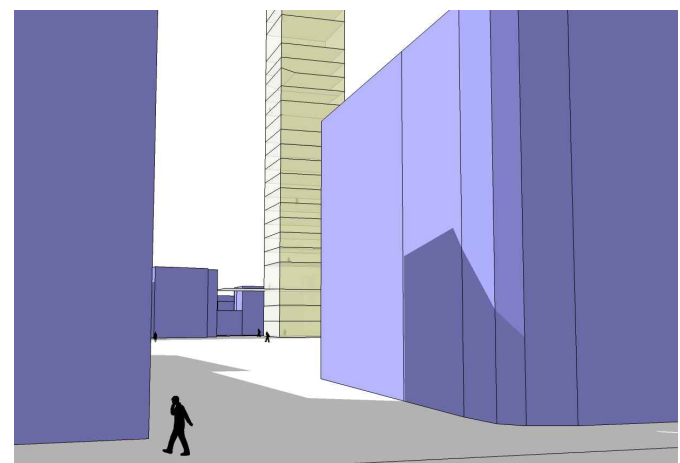
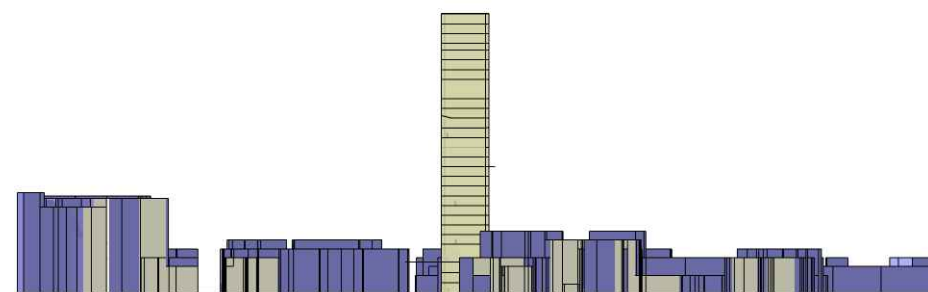
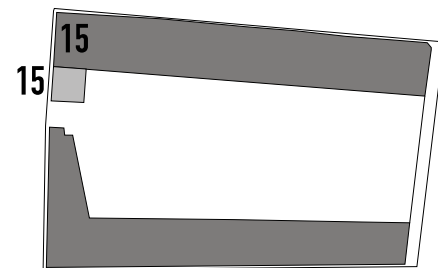



30.03.06 PROPUESTAS SOLAR
 PFC. PABLO REY MAZÓN. ESCUELA FP.
 CICLOS F. SUPERIOR. DISEÑO
 ILUSTRACIÓN GRABADO

todas las medidas en metros

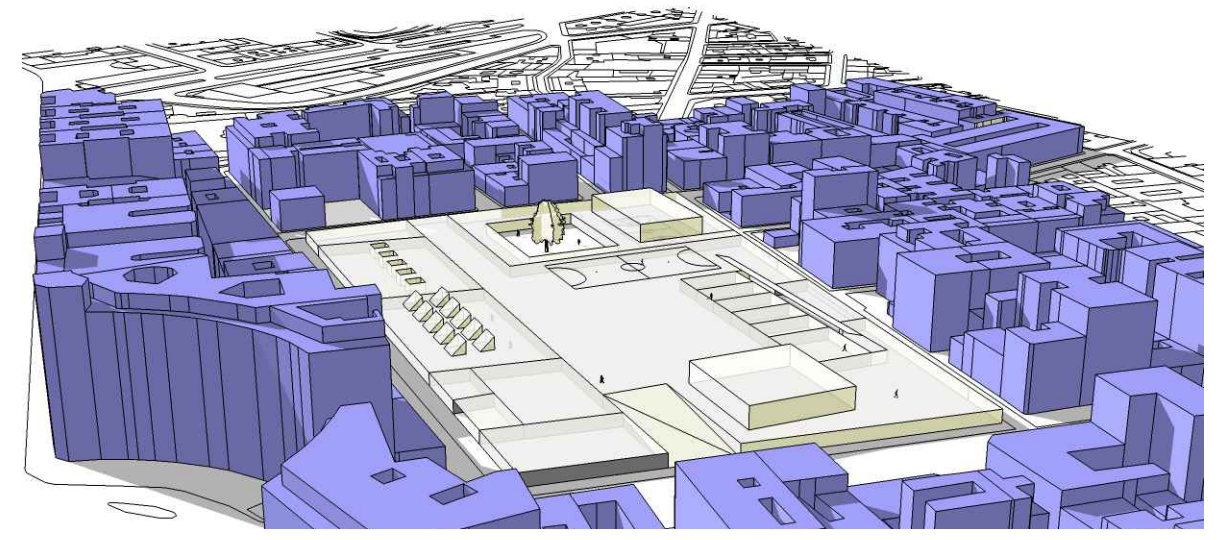

E

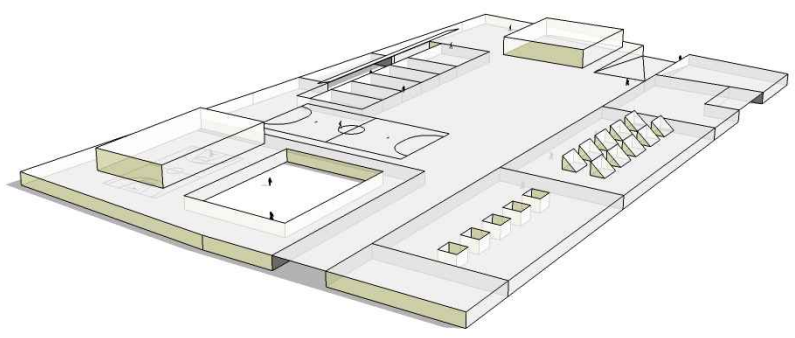

superficie manzana	19256	
m ² construidos pfc:	18076	
m ² ocupados pfc:	18076	93,8%
Superficie libre:	0	0%
Edificios preexistentes:	0	0%
nº de plantas:	1-2	

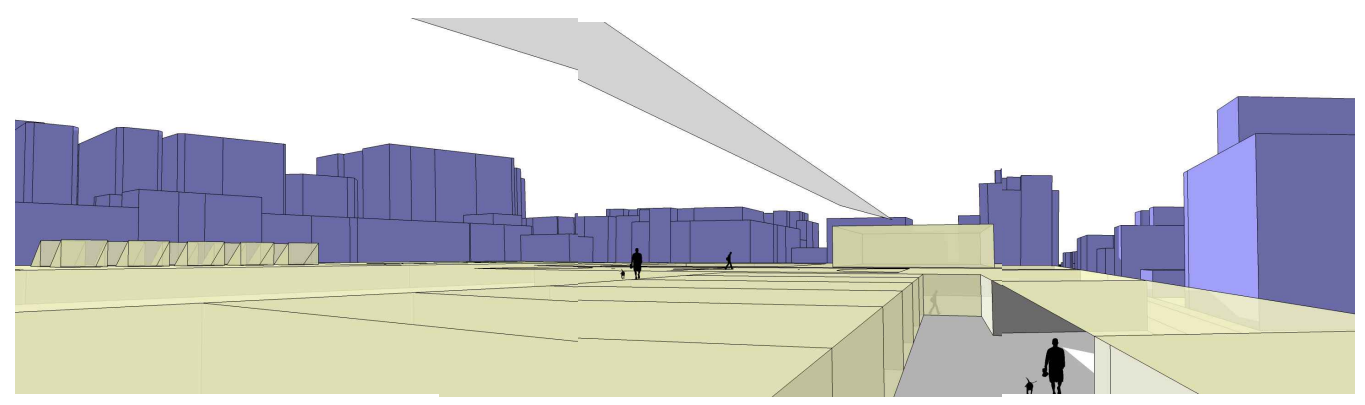
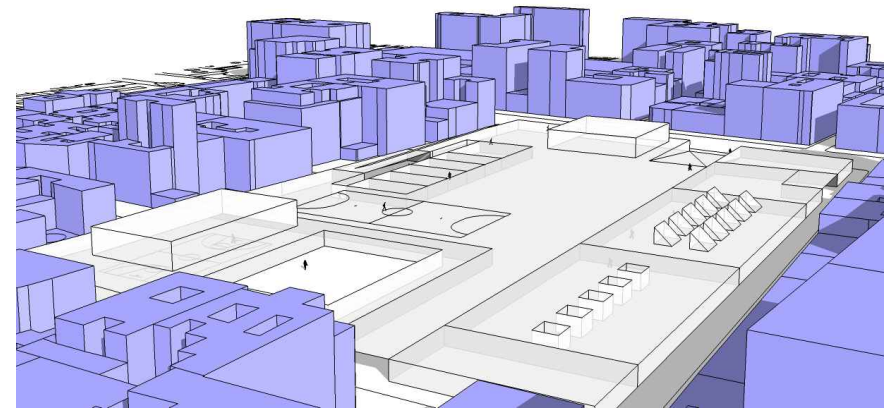
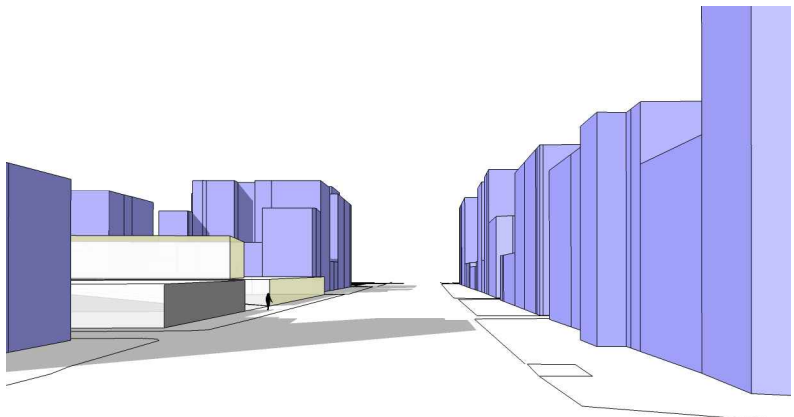
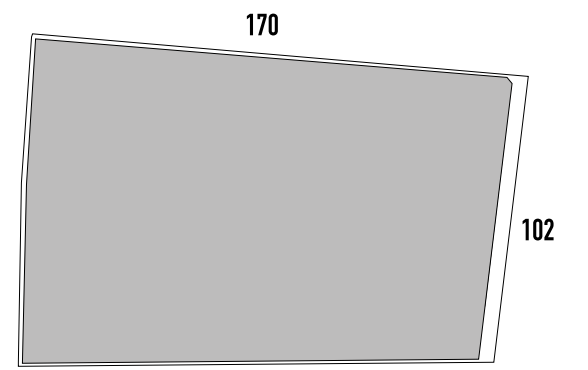



30.03.06 PROPUESTAS SOLAR
 PFC. PABLO REY MAZÓN. ESCUELA FP.
 CICLOS F. SUPERIOR. DISEÑO
 ILUSTRACIÓN GRABADO

todas las medidas en metros

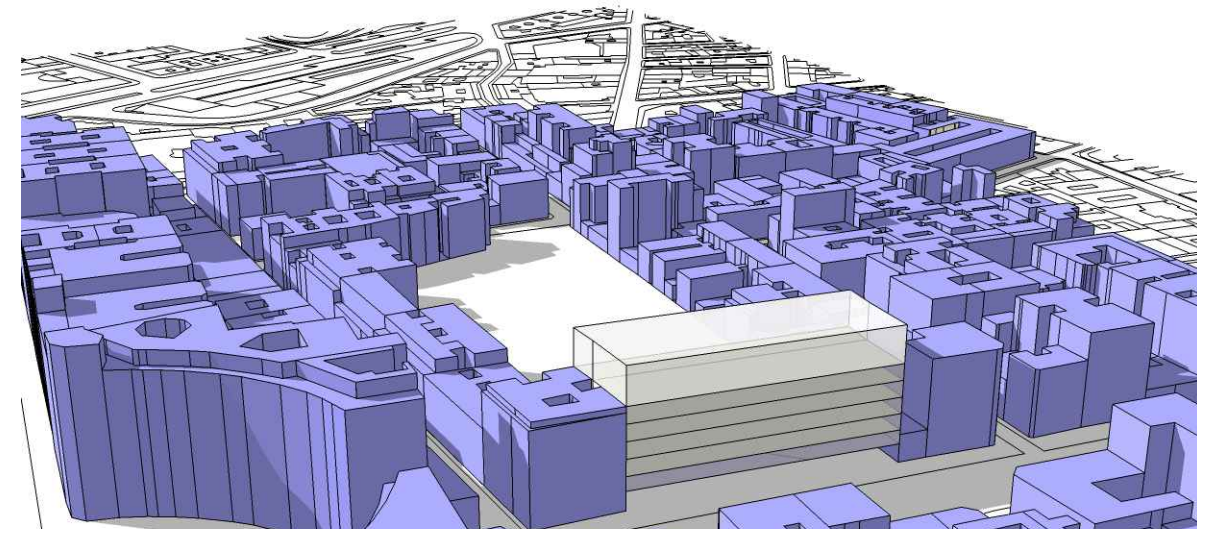

BM

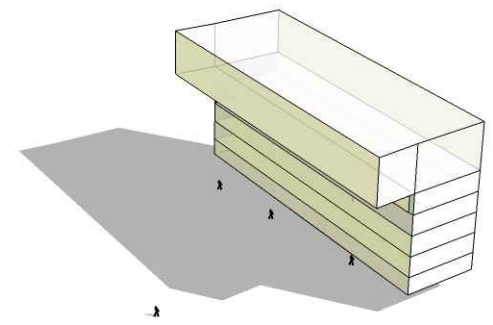

superficie manzana	19256	
m ² construidos pfc:	4902	
m ² ocupados pfc:	741	3,8%
Superficie libre:	9183	47,6%
Edificios preexistentes:	8195	42,5%
nº de plantas:	6	

